

BLOCCHETTO ENTRATA OLIO
OIL INLET SUPPORT

NEW!

CBLT

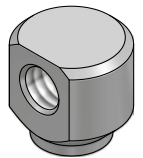
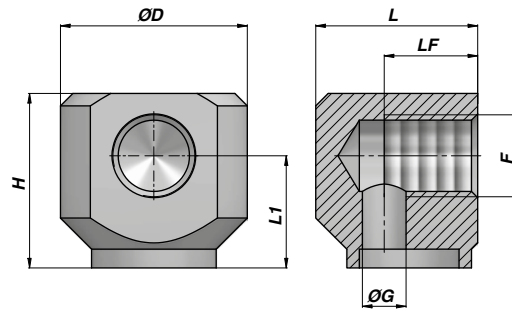

Codice Code	F BSP	LF	L	ØD	H	ØG	L1	kg	Confezione Box	Pz Pcs
CBLT040000	1/4"	15	26.0	30	28	7	18	0,10	Z50CBLT040000	50
CBLT060000	3/8"	20	30.5	35	30	8	18	0,15	Z50CBLT060000	50
CBLT080000	1/2"	22	40.0	45	38	12	23	0,33	Z50CBLT080000	50

MATERIALE : ACCIAIO S355J0 (Fe510C) - S355JR (A105)

MATERIAL : STEEL S355J0 (Fe510C) - S355JR (A105)

INGRASSATORE UNI 7663
GREASE NIPPLE UNI 7663

NEW!

AN / APGR

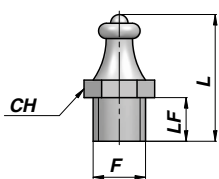

TYPE D

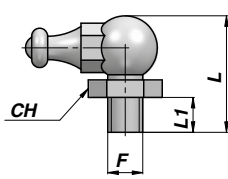

TYPE 90

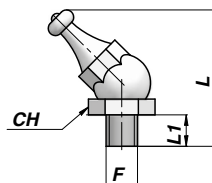

TYPE 45

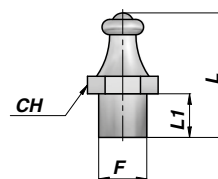

TYPE L

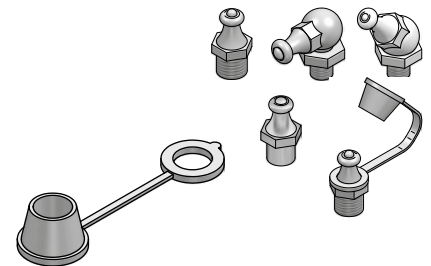

APGR

Codice Code	Tipo Type	F	L1	L	CH	kg x 100	Confezione (Pz.) Box (Pcs)
AN00006001	D	M6x1	5.0	13.5	7	0,20	100
AN00008000	D	M8x1.25	6.0	18.0	11	0,45	100
AN09006001	90	M6x1	6.5	20.5	11	0,90	100
AN09008000	90	M8x1.25	6.5	20.5	11	0,95	100
AN04506001	45	M6x1	6.5	25.5	11	0,94	100
AN04508000	45	M8x1.25	6.5	25.5	11	0,95	100
ANGL000550	L	ø 5.5	5.0	14.0	7	0,20	100
ANGL000800	L	ø 8.0	6.0	17.0	9	0,40	100

APGR013000 TAPPO PROTEZIONE INGRASSATORE - GREASE NIPPLE CAP

MATERIALE INGRASSATORE : ACCIAIO MATERIALE TAPPO PER INGRASSATORE : POLIETILENE L.D.

GREASE NIPPLE MATERIAL : STEEL GREASE NIPPLE CAP MATERIAL : POLYETHYLENE L.D.